

Technical Information - Date 2022-02-15

## LIGHT GRIDS



Take 4 easy steps to configure your light grid:

1. Select a beam spacing between 5 and 112 mm (see page 2)
2. Determine the beam count based on the required monitoring height. (see page 3)
3. Choose the light grid type. (see page 7)
4. Select the profile type according to your mounting requirements (see page 8)

Starting on page 17, you will also find interesting options and suggestions for installation as well as usage of our light grids.

For safety instructions and legal notices please see our separate information leaflet.

**DUOmetric AG**  
Weberstraße 8  
86836 Graben / Germany

Tel: +49-8232-95979-0  
Fax: +49-8232-95979-29

[www.duometric.de](http://www.duometric.de)  
[sales@duometric.de](mailto:sales@duometric.de)

## FUNCTION

In combination with a controller (integrated or external) the system detects the blockage of one or more beams and reacts according to its parameterization.

Details to be defined:

- Beam spacing
- Monitoring height
- Profile dimensions
- Additional options (e.g. different connecting cable options, IP ratings, etc.)

The functions and electrical properties are depending on the type of controller used (e.g. LVE, LVB, LS) and are described in the related technical documentation.

## STEP 1 OF 4.) SELECT THE BEAM SPACING (BS)

The beam spacing defines the distance between the centres of two adjacent light beams. This distance defines the resolution of your light grid (i.e. the minimal size of to-be-detected objects) and the measurement resolution.

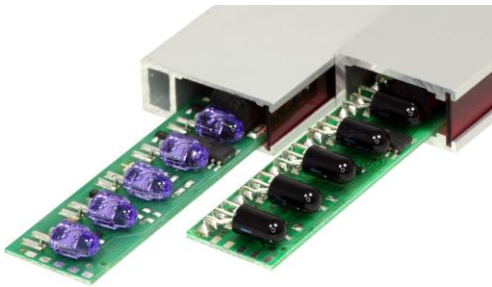

Beam spacing	Module-Typ
5 mm	5
10 mm	10
12,5 mm	12,5
25 mm	25
46 mm	46
50 mm	50
75 mm	75
100 mm	100
Inch beam spacings (not CSA compliant):	
27,94 mm	28
55,88 mm	56
111,76 mm	112

**STEP 2 OF 4.)  
DETERMINE THE BEAM COUNT**

Based on the selected beam spacing and the monitoring height, you determine the total beam count for your light grid.

**Example:**

- 1.) Select desired beam spacing (in this example 25 mm)
- 2.) Find required monitoring height in selected column (in this example 1375 mm)
- 3.) Determine the corresponding beam count (in this example 56 beams)

Technische Information 

Lichtgitterleistenpaare

Strahlanzahl (n)	Strahlabstand (a)									
	5	10	12,5	25	27,94	50	55,88	94	100	111,76
46						2250	2515	4230	4500	5029
47				1150	1285	2300	2570	4324	4600	5141
48	235	470	588	1175	1313	2350	2626	4418	4700	5253
50						2450	2738	4606	4900	5476
51						2500	2794	4700	5000	5588
52						2550	2850	4794	5100	5700
53						2600	2906	4888	5200	5812
54						2650	2962	4982	5300	
55				1350	1509	2700	3018	5076	5400	
56	275	550	688	1375	1537	2750	3073	5170	5500	
58						2850	3185	5358	5700	
59						2900	3241	5452	5800	
60					1475	2950	3297	5546		
61						3000	3353	5640		
62						3050	3409	5734		

### Selection table

MH: Monitoring height: Distance from first to last beam (rounded).

BS: beam spacing

N: beam count

$$MH = BS * ( N - 1 )$$

<b>bold</b>	Preference types
grey	On request
grey background	Not available für LS, for example spacing 27,94; 46; 94; 55,88 and 111,76.

Beam count (N)	Beam spacing (BS)										
	5	10	12,5	25	27,94	46	50	55,88	75	100	111,76
4				75		138	150	168	225	300	<b>335</b>
5				100		184	200	224	300	400	447
6				125		230	250	279	375	500	559
7				150	168	276	300	335	450	600	671
8	<b>35</b>	<b>70</b>	<b>88</b>	<b>175</b>	<b>196</b>	<b>322</b>	<b>350</b>	<b>391</b>	525	<b>700</b>	<b>782</b>
9		80	100	200		368	400		600	800	894
10		90	113	225		414	450	503	<b>675</b>	900	1006
11		100	125	250		460	500	559	750	1000	1118
12		110	138	<b>275</b>		506	550	615	825	<b>1100</b>	<b>1229</b>
13		120	150	300		552	600	671	900	1200	1341
14		130	163	325		598	650	726	975	1300	1453
15		140	175	350	391	644	700	782	<b>1050</b>	1400	1565
16	<b>75</b>	<b>150</b>	<b>188</b>	<b>375</b>	<b>419</b>	<b>690</b>	<b>750</b>	<b>838</b>	1125	<b>1500</b>	<b>1676</b>
17		160	200	400		736	800		1200	1600	1788
18		170	213	425		782	850	950	1275	1700	1900
19		180	225	450		828	900	1006	1350	1800	2012
20		190	238	<b>475</b>		874	950	1062	<b>1425</b>	<b>1900</b>	<b>2123</b>
21		200	250	500		920	1000	1118	1500	2000	2235
22		210	263	525		966	1050	1173	1575	2100	2347
23		220	275	550	615	1012	1100	1229	1650	2200	2459
24	<b>115</b>	<b>230</b>	<b>288</b>	<b>575</b>	<b>643</b>	<b>1058</b>	<b>1150</b>	<b>1285</b>	1725	<b>2300</b>	<b>2570</b>
25		240	300	600		1104	1200		<b>1800</b>	2400	2682
26		250	313	625		1150	1250	1397	1875	2500	2794
27		260	325	650		1196	1300	1453	1950	2600	2906
28		270	338	<b>675</b>		1242	1350	1509	2025	<b>2700</b>	<b>3018</b>
29		280	350	700		1288	1400	1565	2100	2800	3129
30		290	363	725		1334	1450	1621	<b>2175</b>	2900	3241
31		300	375	750	838	1380	1500	1676	2250	3000	3353
32	<b>155</b>	<b>310</b>	<b>388</b>	<b>775</b>	<b>866</b>	<b>1426</b>	<b>1550</b>	<b>1732</b>	2325	<b>3100</b>	<b>3465</b>
33		320	400	800		1472	1600		2400	3200	3576
34		330	413	825		1518	1650	1844	2475	3300	3688
35		340	425	850		1564	1700	1900	<b>2550</b>	3400	3800
36		350	438	<b>875</b>		1610	1750	1956	2625	<b>3500</b>	<b>3912</b>
37		360	450	900		1656	1800	2012	2700	3600	4023
38		370	463	925		1702	1850	2068	2775	3700	4135
39		380	475	950	1062	1748	1900	2123	2850	3800	4247
40	<b>195</b>	<b>390</b>	<b>488</b>	<b>975</b>	<b>1090</b>	<b>1794</b>	<b>1950</b>	<b>2179</b>	<b>2925</b>	<b>3900</b>	<b>4359</b>
41		400	500	1000		1840	2000		3000	4000	4470
42		410	513	1025		1886	2050	2291	3075	4100	4582
43		420	525	1050		1932	2100	2347	3150	4200	4694
44		430	538	<b>1075</b>		1978	2150	2403	3225	<b>4300</b>	<b>4806</b>
45		440	550	1100		2024	2200	2459	<b>3300</b>	4400	4917

Beam count (N)	Beam spacing (BS)										
	5	10	12,5	25	27,94	46	50	55,88	75	100	111,76
46		450	563	1125		2070	2250	2515	3375	4500	5029
47		460	575	1150	1285	2116	2300	2570	3450	4600	5141
48	235	470	588	1175	1313	2162	2350	2626	3525	4700	5253
49		480	600	1200		2208	2400		3600	4800	5364
50		490	613	1225		2254	2450	2738	3775	4900	5476
51		500	625	1250		2300	2500	2794	3850	5000	5588
52		510	638	1275		2346	2550	2850	3925	5100	5700
53		520	650	1300		2392	2600	2906	4000	5200	5812
54		530	663	1325		2438	2650	2962	4075	5300	
55		540	675	1350	1509	2484	2700	3018	4150	5400	
56	275	550	688	1375	1537	2530	2750	3073	4225	5500	
57		560	700	1400		2576	2800		4300	5600	
58		570	713	1425		2622	2850	3185	4375	5700	
59		580	725	1450		2668	2900	3241	4450	5800	
60		590	738	1475		2714	2950	3297	4525		
61		600	750	1500		2760	3000	3353	4600		
62		610	763	1525		2806	3050	3409	4675		
63		620	775	1550	1732	2852	3100	3465	4750		
64	315	630	788	1575	1760	2898	3150	3520	4825		
65		640	800	1600		2944	3200		4900		
66		650	813	1625		2990	3250	3632	4975		
67		660	825	1650		3036	3300	3688	5050		
68		670	838	1675		3082	3350	3744	5125		
69		680	850	1700		3128	3400	3800	5200		
70		690	863	1725		3174	3450	3856	5275		
71		700	875	1750	1956	3220	3500	3912	5350		
72	355	710	888	1775	1984	3266	3550	3967	5425		
73		720	900	1800		3312	3600		5500		
74		730	913	1825		3358	3650	4079	5575		
75		740	925	1850		3404	3700	4135	5650		
76		750	938	1875		3450	3750	4191	5725		
77		760	950	1900		3496	3800	4247	5800		
78		770	963	1925		3542	3850	4303			
79		780	975	1950	2179	3588	3900	4359			
80	395	790	988	1975	2207	3634	3950	4415			
81		800	1000	2000		3680	4000				
82		810	1013	2025		3726	4050	4526			
83		820	1025	2050		3772	4100	4582			
84		830	1038	2075		3818	4150	4638			
85		840	1050	2100		3864	4200	4694			
86		850	1063	2125		3910	4250	4750			
87		860	1075	2150	2403	3956	4300	4806			
88	435	870	1088	2175	2431	4002	4350	4862			
89		880	1100	2200		4048	4400				
90		890	1113	2225		4094	4450	4973			
91		900	1125	2250		4140	4500	5029			
92		910	1138	2275		4186	4550	5085			
93		920	1150	2300		4232	4600	5141			
94		930	1163	2325		4278	4650	5197			
95		940	1175	2350	2626	4324	4700	5253			
96	475	950	1188	2375	2654	4370	4750	5309			
97		960	1200	2400		4416	4800				
98		970	1213	2425		4462	4850	5420			
99		980	1225	2450		4508	4900	5476			
100		990	1238	2475		4554	4950	5532			

Beam count (N)	Beam spacing (BS)							
	5	10	12,5	25	27,94	46	50	55,88
101		1000	1250	2500		4600	5000	5588
102		1010	1263	2525		4646	5050	5644
103		1020	1275	2550	2850	4692	5100	5700
104	515	1030	1288	2575	2878	4738	5150	5756
105		1040	1300	2600		4784	5200	
106		1050	1313	2625		4830	5250	
107		1060	1325	2650		4876	5300	
108		1070	1338	2675		4922	5350	
109		1080	1350	2700		4968	5400	
110		1090	1363	2725		5014	5450	
111		1100	1375	2750	3073	5060	5500	
112	555	1110	1388	2775	3101	5106	5550	
119		1180	1475	2950	3297	5428		
120	595	1190	1488	2975	3325	5474		
127		1260	1575	3150	3520	5796		
128	635	1270	1588	3175	3548			
135		1340	1675	3350	3744			
136	675	1350	1688	3375	3772			
143		1420	1775	3550	3967			
144	715	1430	1788	3575	3995			
151		1500	1875	3750	4191			
152	755	1510	1888	3775	4219			
159		1580	1975	3950	4415			
160	795	1590	1988	3975	4442			LA, LS max. 160 beams
167		1660	2075	4150	4638			
168	835	1670	2088	4175	4666			
175		1740	2175	4350	4862			
176	875	1750	2188	4375	4890			
183		1820	2275	4550	5085			
184	915	1830	2288	4575	5113			
191		1900	2375	4750	5309			
192	955	1910	2388	4775	5337			
199		1980	2475	4950	5532			
200	995	1990	2488	4975	5560			
207		2060	2575	5150	5756			
208	1035	2070	2588	5175	5784			
215		2140	2675	5350				
216	1075	2150	2688	5375				
223		2220	2775	5550				
224	1115	2230	2788	5575				
231		2300	2875	5750				
232	1155	2310	2888	5775				
240	1195	2390	2988					
248	1235	2470	3088					
256	1275	2550	3188					
264	1315	2630	3288					
272	1355	2710	3388					
280	1395	2790	3488					
288	1435	2870	3588					
296	1475	2950	3688					

## STEP 3 OF 4.) SELECT A LIGHT GRID TYPE



With the previously determined beam count choose a light grid type according to your requirements.

### Summary

Type	Controller <sup>1</sup>	Max. beam count	Cycle time	Description
<b>Switching</b>				
LS LA	integrated	160	1 ms/beam + 4 ms	Cost effective system for modest requirements, switching output, parameterisable, optical synchronization, 24 VDC
LI	LVB LVR	500	from 70 µs/beam	Two redundant safety relays; 230 Vac and 24 VDC
<b>Measuring</b>				
LI	LVX, LVE LVE2	1200 <sup>[2]</sup>	from 30 µs/beam	The standard unit for most measuring requirements. Fast data processing. Variety of standardized interfaces for straight forward implementation
LF	FAW	256	from 6 µs/beam	Ultra-fast processing for demanding applications

### Standard connectivity

The connection to the controller is made via a permanently installed cable (standard length 4m). For pin assignments please refer to the technical documentation of the individual controller units.

Type	Picture	Comment
LS		M8 connector on profile
LA		Ferrules
LI, LF		Terminal block Phoenix Contact CombiCon Non-interchangeable coded

<sup>1</sup> Also see product descriptions for controller units

<sup>2</sup> Logical beams. With more than 368 physical beams an individual examination is required

**STEP 4 OF 4.)  
CHOOSE PROFILE AND MOUNTING OPTION**

Using beam spacing and monitoring height derived in steps 1 & 2 you now can define the mechanical format of the light grid profiles.

**Profile length**

Calculate the total profile length (L) by using the selected beam count (n), beam spacing (a) together with profile excess lengths X and Y:

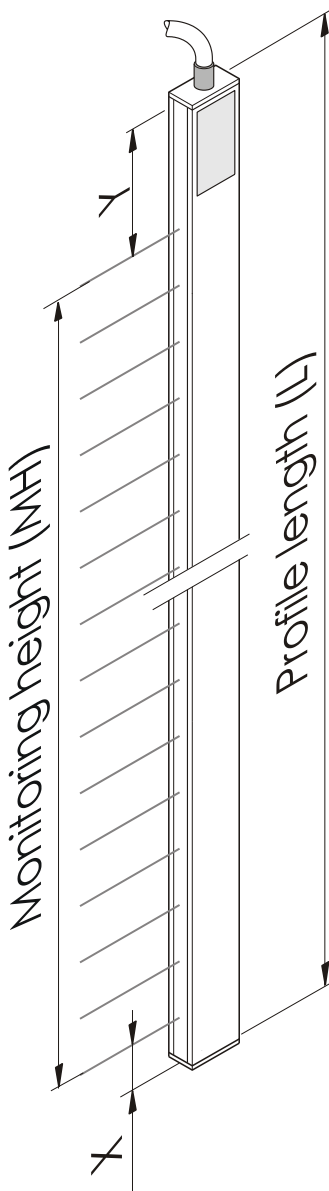

$$L = MH + X + Y_{\min}$$

(rounded to the next 10 mm)

$$\text{with } MH = BS * (N - 1)$$

Profile excess length  $Y_{\min}$  and X:

Module-Type	LI, LF	$Y_{\min}^1$		X (all Types)
		LA	LS	
B 5	17,5	67,5	67,5	17,5
e 10	38,5	153,5	50,0	13,5
i 12,5	38,5	153,5	48,0	
s 25	45,0	160,0	50,0	20,0
p 28	45,0	160,0		
i 46	45,0	160,0	60,0	
e 50	70,0	185,0	60,0	
l 56	70,0	185,0		
: 75	45,0	160,0		
100	130,0	245,0	60,0	
L 112	130,0	245,0		

Example: LI32/56, profile type I  
Beam count = 32, Modultype = 56



- ⇒ (from table)  $Y_{\min} = 70$  mm,  $X = 20$  mm
- ⇒ (from step 1) beam spacing = 55,88 mm
- ⇒  $MH = 55,88 \text{ mm} \times (32 - 1) = 1732$  mm
- ⇒  $MH + X + Y = 1822$  mm
- ⇒  $L = 1830$  mm (rounded)
- ⇒  $Y = 1830 - 20 - 1732 = 78$  mm

Tolerances of beam position:  $\pm 2$  mm; all dimensions in mm.  
Longer profiles are available at extra charge.

<sup>1</sup> The actual values (Y) can be higher e.g. due to rounding!

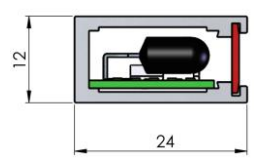
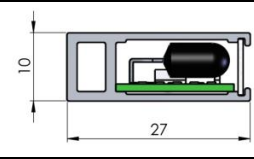
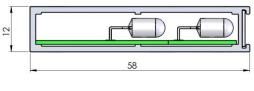
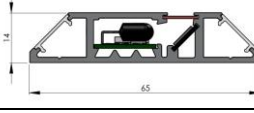
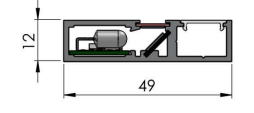

### Overview Profile Types

Acronym		Cross section in mm	max. profile length	Description
I		12x24	6 m	M4 studs distributed over the whole profile length. Standard configuration in the industrial environment.
Q		10x27	4 m	Cross-hole for flat assembly
T		12x58	3 m	For 5mm beam spacing only; Cross-hole for flat assembly, M4 thread at ends
Z		14x65	3 m	Vertical beam exit; no mounting holes, drill groove in mounting chamber
R		12x49	3 m	Vertical beam exit; rectangular cross section; no mounting holes, drill groove in mounting chamber
A		12x24	2,5 m	Bottom: spigot Top: M4 studs Standard configuration for elevators.

Profile Drawings

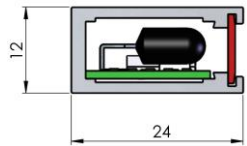
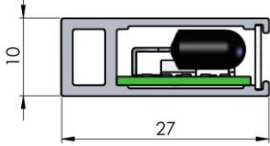
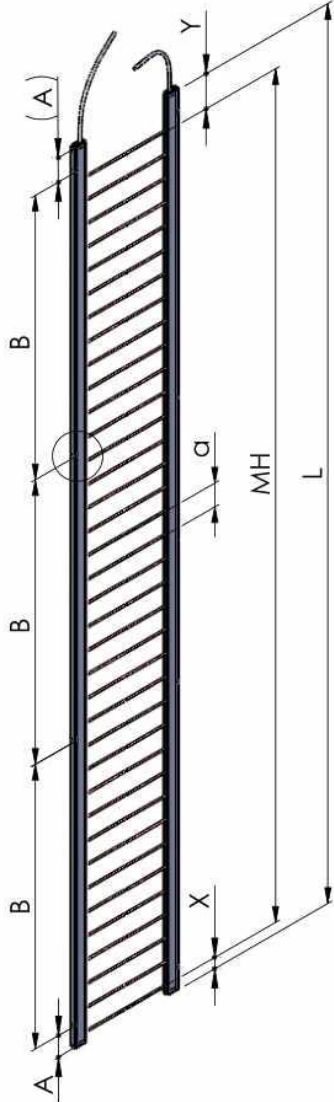
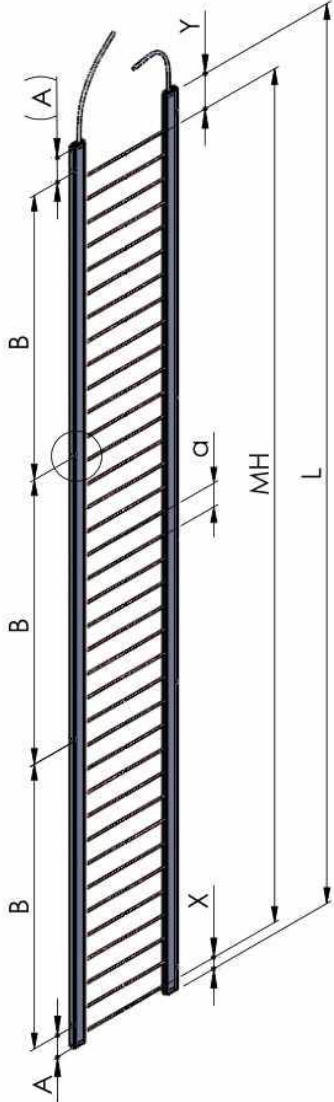
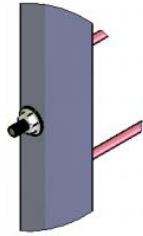
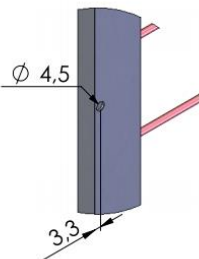
Profile "I" (12x24)	Profile "Q" (10x27)
	
	
 <p>Backside threaded bolt M4x10</p>	 <p>Mounting hole Ø4,5 mm</p>

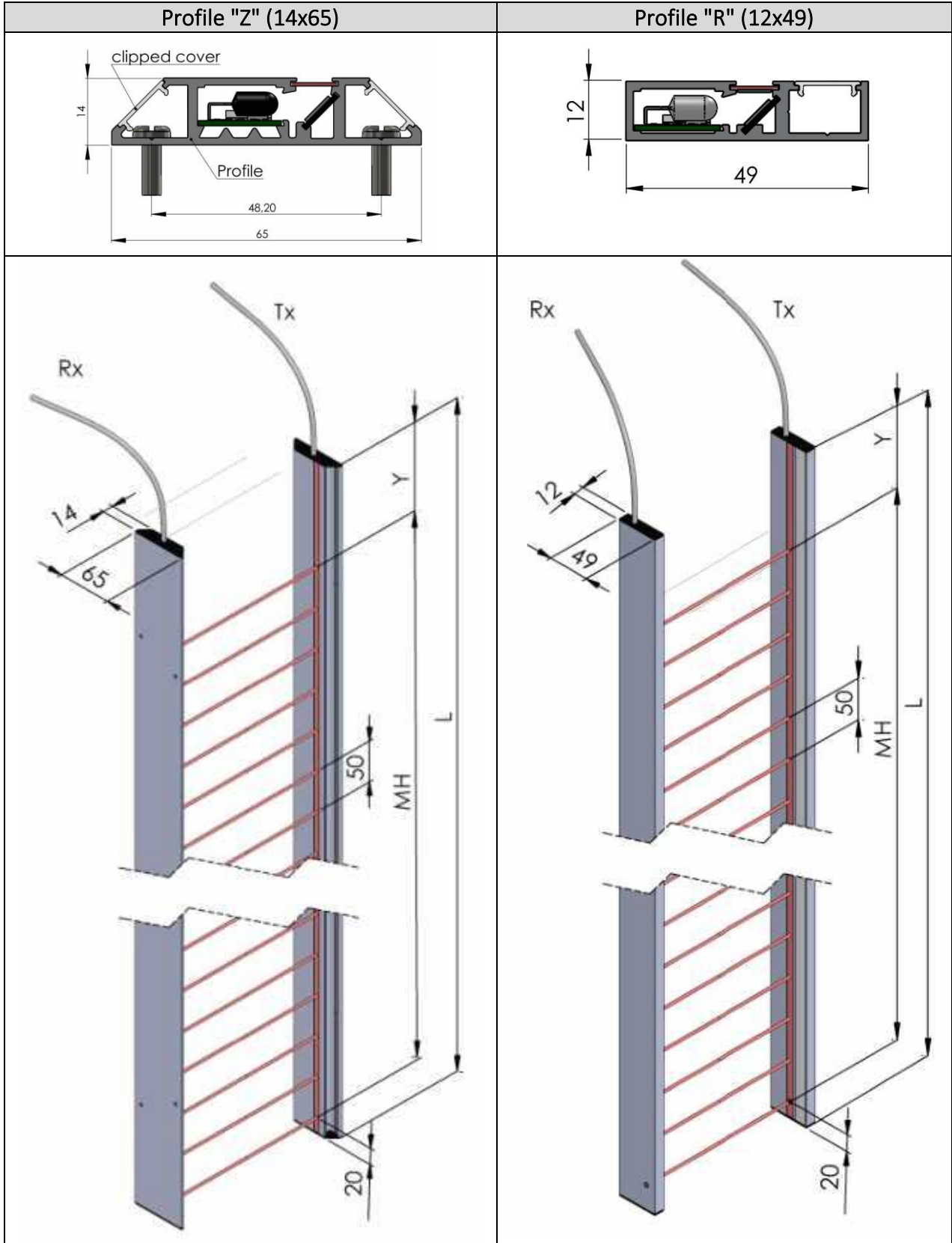

For 5 mm beam spacing

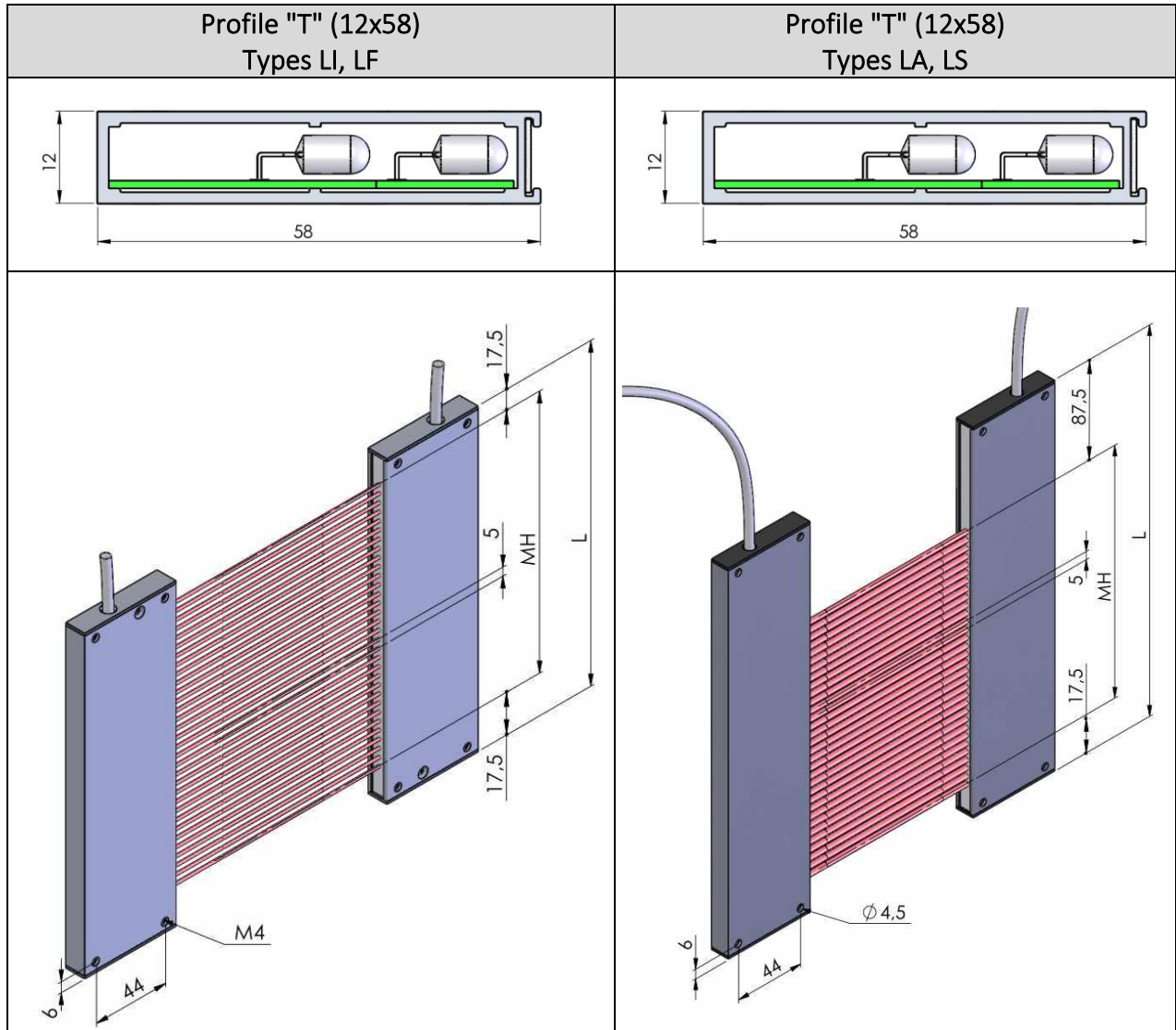

### Type A profiles for Elevators

The proven mounting method in elevators: allows for quick and easy fitting in elevator door frames, door sills and imposts.

Characteristics:

- 4xM4-threaded bolt above
- Spigot at bottom
- Preferred length: 2000 or 2400 mm  
Minimum length (see page 8):  $L = MH + X + Y$ ;  
Max length: 2500 mm

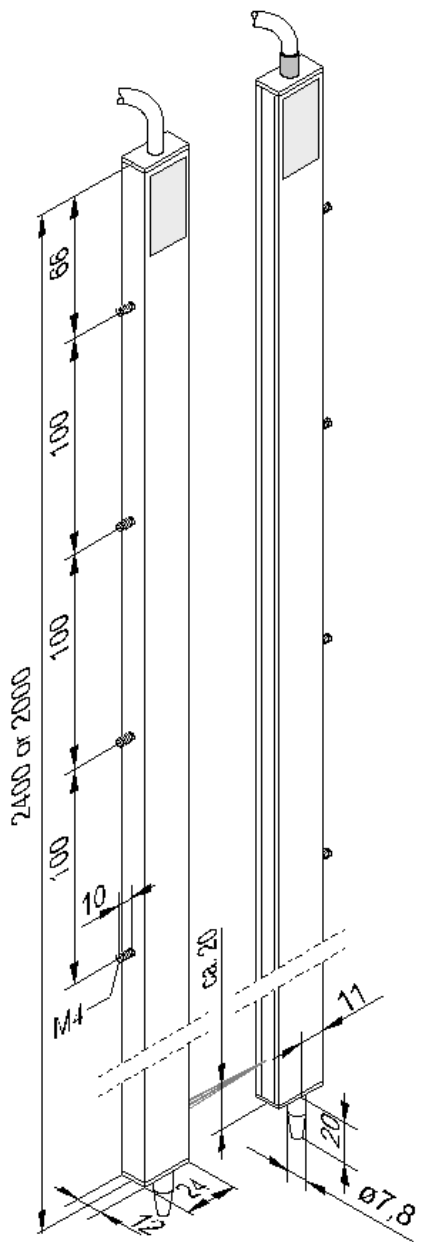

#### Installation Kit Kombi:

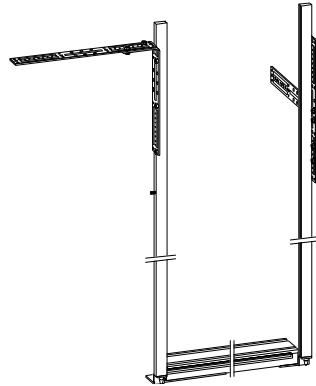

#### Installation Kit Sematic

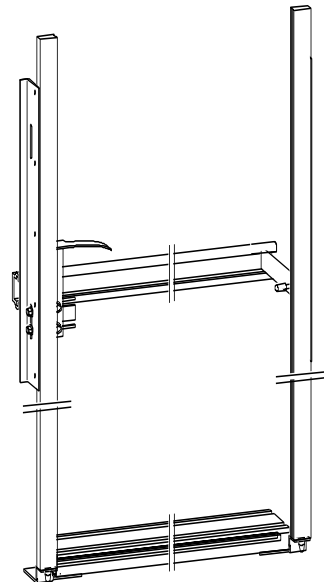

#### Installation Kit Meiller

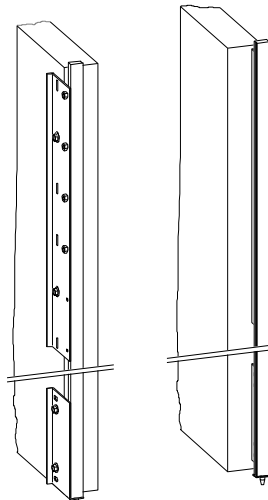

### Distances and numbers of mounting elements

Profile	Mounting element	Cross section
I	M4x10 threaded bolt	12x24
Q	Cross-hole	10x27

Options:

- Longer threaded bolts
- Other positions of mounting elements

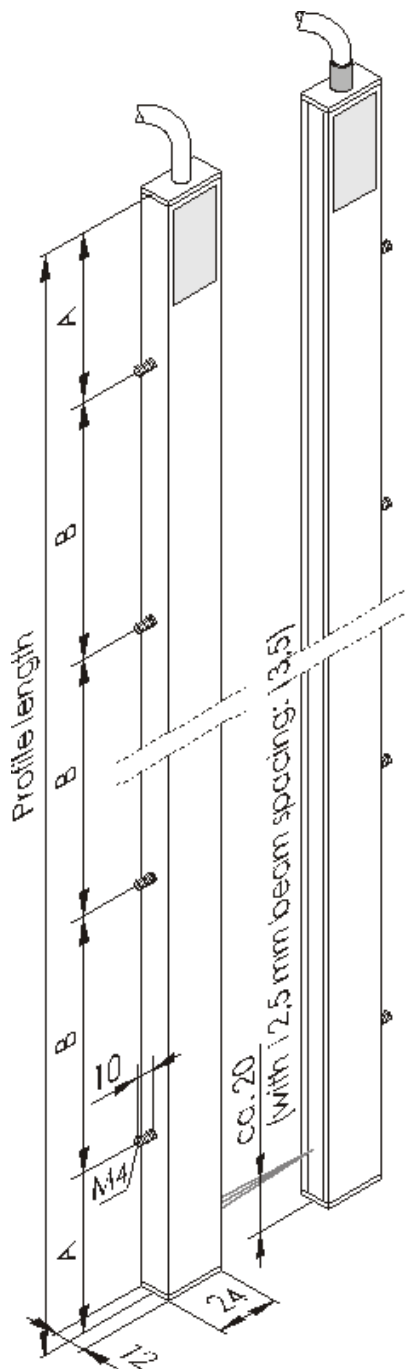

length (L)	distance (B)	Number of mounting elements (Z)
120...140	90	2
141...250	100	2
260...350	200	2
360...500	300	2
510...620	400	2
630...660	500	2
670...750	600	2
760...890	700	2
900...950	800	2
960...1100	400	3
1110...1250	500	3
1260...1450	600	3
1460...1550	400	4
1560...1850	500	4
1860...2060	600	4
2070...2350	500	5
2360...2450	520	5
2460...2750	600	5
2760...2890	500	6
2900...2950	520	6
2960...3140	700	5
3150...3350	600	6
3360...3560	800	5
3570...3860	700	6
3870...4030	520	8
4040...4300	900	5
4310...4570	700	7
4580...4850	500	10
4860...5130	800	7
5140...5250	700	8
5260...5450	520	11
5460...5650	600	10
5660...5850	800	8

Equation for distance "A":  $A = 0,5 \times (L - B \times (Z - 1))$

## TOLERANCES

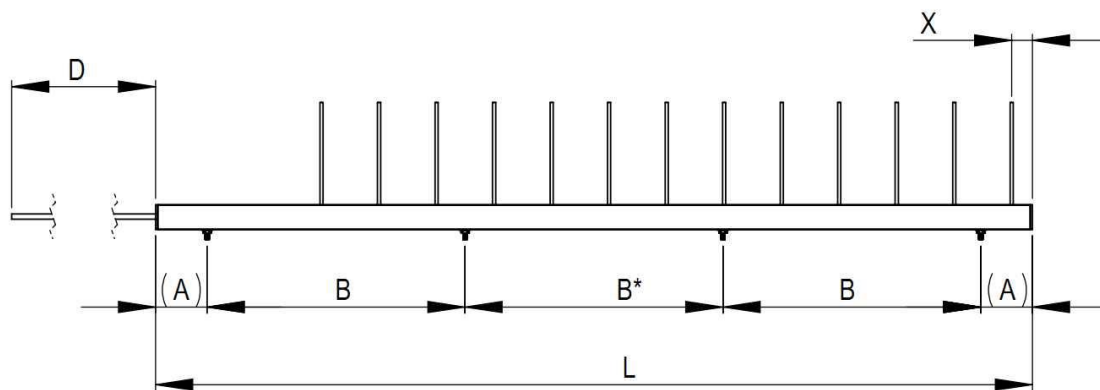

### Distances for mounting elements

Dimensions in mm:

Nominal length in mm	over 20 up to 120	over 120 up to 400	over 400 up to 1000	over 1000 up to 2000	over 2000 up to 4000
Distance (A)	±0,3	±0,5			
Distance (B) for mounting elements	±0,3	±0,5	±0,8	±1,2	
Profile length (L)	±0,8	±1,2	±2,0	±3,0	±4,0

According to DIN ISO 2768-1. Tolerances for nominal lengths >4000 mm on request.

Tolerance for B\* for profile lengths over 2000 up to 4000 mm: ±2,0 mm<sup>1</sup>

### Cable length (D)

Tolerance cable length: ±1%, minimum ±1 cm.

### Beam Position

Typical tolerance for beam position: ±2 mm. Smaller tolerances on request.

## Further Particulars

If not stated differently the following applies:

- Optical appearance anodized surface: DIN EN 17611:2000-12
- Torsion: DIN EN 755-9
- Min. bending fixed: approx. 30mm;  
detailed information's (depending on version and type) on request.

<sup>1</sup> For profile lengths above 20000 mm B\* refer to the distance between the two centre bolts or the distance between the centre bolt and the next bolt.

## SUMMARY / TECHNICAL DATA LIGHT GRIDS

Detail	Description					
Profile	Q	I	Z	R	T	A
Cross-section [mm <sup>2</sup> ]	10x27	12x24	14x65	12x49	12x58	12x24
Max. length [mm]	4000	6000	2960	2960	3000	2000 2400
Housing material	Clear anodised aluminium Front cover plastic red, transparent					
IP rating acc. to DIN 40050	IP 54 for internal and external use (higher ip rating on request)					
Humidity	Up to 90 % relative, non-condensing					
Temperature	-30°C -+55°C Please note specifications for external controller! For CSA compliant use: -20.....+40°C					
Illuminant	Infrared, approx. 800 - 1000 nm Other wavelengths on request					
Allowed angular deviation	+/- 10° (between transmitter and receiver)					
Ambient light immunity	High ambient light immunity, avoid direct sunlight (DC light) towards the receiver					
Wiring cable	Attached wiring cable, length 4 m (± 1%); PVC;					
EMC immunity	Refer to technical information of the control unit					

## EXAMPLE FOR ORDERING TEXT (SHORT)

LI82/25-2090I, AC:00000000

Light grid Type LI for controller LVX/LVE

- Beam spacing: 25 mm
- Monitoring height: 2025 mm
- Profile cross-section: 12x24 mm<sup>2</sup>
- Profile Length: 2090 mm
- Colour: clear anodised
- Mounting: 5 threaded bolts M4x10 in 500 mm distances
- IP rating: IP54
- Wiring cable: 4 m with terminal plugs



## OPTIONS

### Profile colour

A1	A2	A3	A4	A5	A6	A7	A8

A 1	Description
0	Standard: clear anodised
N	Clear anodised
B	Blank
S	Black anodised
R	Powder coating in RAL colours
...	Additional colours on request

### Cable length

A1	A2	A3	A4	A5	A6	A7	A8

A 2,3,4	Description
000	Standard (4 m)
005	0,5 m
100	10 m
150	15 m

### Note:

- Maximum-length: 25 m with LVX, LVE, LVB and 30 m for LA. 2m with FAW.
- Use longer cables preferably on transmitter side
- Cable lengths excluding connectors
- Please contact our technical support if you want to:
  - Make changes at the connector cable (e.g. lengthening; use of different connectors).
  - Use two light grid sets on one control unit with more than 4 m connector cable each.

### Cable outlet

A1	A2	A3	A4	A5	A6	A7	A8

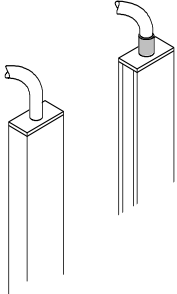
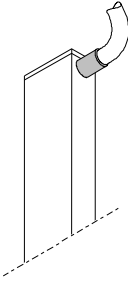
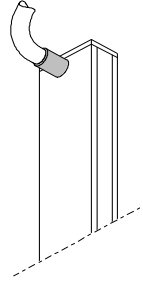
A 5	0	H	F
Description	standard, front side	"backward"	"side looking"
Sketch			

## Range

The range of our light grids essentially depends on the control units.  
Please adhere to the corresponding specifications.

## Range/Profile Types

Profile	Relative range
R, Z	60%
T	80%
others	100%

## Options for transmitter

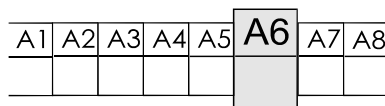

A 6	Relative range	Example range for LVX*
<b>1</b>	<b>25 %</b>	<b>&gt; 60 mm</b>
8	40 %	> 100 mm
7	53 %	> 180 mm
0	100 %	250 to 6000 mm
6	114 %	< 7000 mm
3	124 %	< 7500 mm
5	130 %	< 8000 mm
4	137 %	< 8300 mm
<b>9</b>	<b>156 %</b>	<b>&lt; 9300 mm</b>
2	on request (special-LED)	

\*Values are measured limits, the limits have to be tested in the application.

Preferential types are bold.

LA/LC and relative range >100%: Intensive tests are necessary. Please contact our technical support.

## Options for receiver

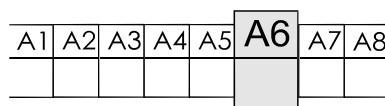

A 6	Receiver cable
N	single shielded
0	double shielded <sup>1</sup>

## Options for LED indicator strip

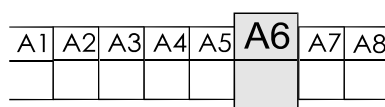

A 6	Description
0	red LED
G	green LED

<sup>1</sup> standard type for LI ex October 2006, all other ex April 2007.

### Front cover

A1	A2	A3	A4	A5	A6	A7	A8

A 7	Description
0	Standard: PVC, red transparent
B	PC, red printed
S	PMMA, black
G	Glass window
W	PMMA, white diffuse
F	PVC, red transparent with peel-off protection foil
K	Clear plastic window with scratch-resistant coating

### Cable type

A1	A2	A3	A4	A5	A6	A7	A8

A 8	Type		Description
	LA LS	LI LF	
0	X	X	Standard, according to light grid type.
H	X	X	Non-halogen; cable casing PUR; Schleppflex; cable diameter 6,0 ±0,3 mm
C	X	X	M12 connector with 0,75 m connector cable. For LI: 5-pole, shielded Transmitter (red marking) female connector Receiver: Male connector For LA, LS: 4-pole Transmitter and Receiver with male connector
A	X	-	With Phoenix Contact CombiCon connector.
W	X	-	With Wago connector.
D	X	-	With diode connector
M	X	-	M8 connector (4 pin at transmitter and receiver)
B	-	X	Pre-assembled M12 fitting and Phoenix Contact CombiCon, e.g. for control unit type LVB and LVR
E	-	-	Screw-type round connector for heating 230V
S	X	X	Special version - see product description



For detailed specification please contact our technical support!

### Example

AC: S150H10GC:

Black anodized; 15m wire length, cable outlet "backward"; reduced transmission power; glass front cover; connection via M12-plug.

## IP RATING

### Important notes:

- IP rating is specified for intended use only.
- Adhere to the information „Mounting Instructions for Light Grid“, „Starting up control unit...“ as well as addendum regarding IP rating.

IP rating can be affected by changes to the devices (e.g. removing labels, loosen a screw, trimming a stud bolt, drill through the housing). Any changes to the device will void warranty.

### Options:

Type	Description
-IP20	IP rating IP20 for all light grids
-IP54	Standard: IP rating IP54 for all light grids
-IP65	IP rating IP65 for type LI only
...	

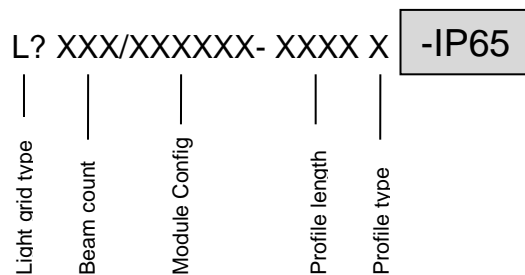

## ACCESSORY / ADAPTER PLUGS

Type	Description
LILVM	Allows for the connection of grids type LI to control unit LVM. IP rating IP00
M12LVX	Connector cable (set) with M12 connectors. For connecting a trans-mitter or receiver with option M12 to the control unit LVX or LVE.
FP-30-00012	Mounting kit for „isolated mounting“ of profiles type T
FP-30-00013	Mounting kit for „isolated mounting“ of profile types I
Clip####	Cover strip; PMMA; white transparent; for profile types R and Z. length #### mm, max. 3000 mm Example: Clip2100 for LI40/50-2100Z or LI40/50-2100R

## SPECIAL VARIANTS

The following variants are not part of our standard product offering. Additional information is available on request.

Profile	F	H	M	L	N	O
Cross-section	40x12	12x24	12x24	10x27	10x27	12x24
Description	Vertical beam outlet	2 bushings $\varnothing 4.5$ ; for flat mounting	2xM3 threads at ends; for flat mounting	Compartment for nuts and screw heads	No mounting holes	No threaded bolts
Alternative	R, Z	Q	Q	I		
Sketch						

## DETAILS FOR INITIAL SETUP AND USAGE

- Perform the initial light grid setup carefully and in accordance to our mounting instructions, the technical documentations and the relevant regulations. Adhere to EMC compliant handling of the shielded connector cable for types LI and LF.
- The controller must be switched off when connecting or disconnecting the profiles!
- It is generally not necessary to align the profiles exactly. Only in special cases it should be necessary to adjust the profiles. Note that the profiles may also need to be moved longitudinally.

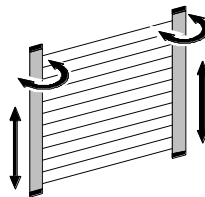

- The monitored area between the transmitter and receiver must be clear of obstructions so that the grids can “see” each other.
- Do not expose the profiles to mechanical stress.

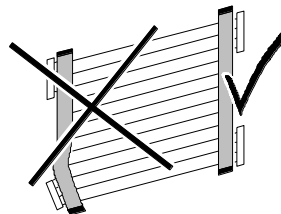

- Avoid ground loops: Profiles must have the same ground potential.
- Avoid the effects of external light sources (e.g., from flashlights or sunlight) on the receiver.

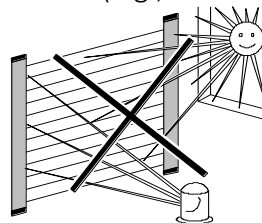

- Condensation, fog or smoke can impair the functioning of a light grid.
- The front cover must not be scratched. It must be kept free of obstacles and it must be kept clean (do not use any cleaning agents containing solvents). Clean only with a moist cloth.

- Danger from reflective surfaces: Reflective surfaces in the area around the light grid must be avoided. Otherwise objects may not be detected.  
Optical sensors can influence each other by reflections. This could impair the functionality of the devices.

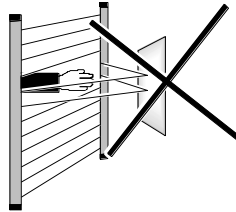

- Ensure that different optical sensors do not mutually influence each other (e.g., other light grids/curtains, light barriers, ...)

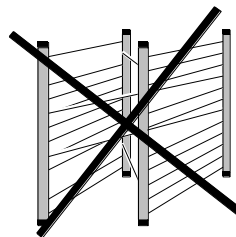

- Use a test pin to check that the light grid is working in the entire monitoring area.
- Connections must be done EMC compliant.  
Note: unshielded cable length of wires shall not exceed 20 mm.
- Warranty is voided if any changes are made to the light grid connector cables or the connectors!
- A voltage difference of 60V between the profiles and the supply voltage must not be exceeded.
- Do not use high-pressure washers or steam cleaners.
- Attention with horizontally mounted profiles:  
There is no IP rating warranty in this position! Increased risk of contamination! Fluid on the front foil can interrupt the beams and enter the profiles!

## FURTHER DESIGN OPTIONS

Have you not yet found a solution? Then please contact our sales department, we will help with innovative ideas. Furthermore, here are examples of special solutions we have created in the past:

**Segmentation**, ze.g. for arrays in a poka yoke system

Halving of the beam spacing by offset mounting of profiles:

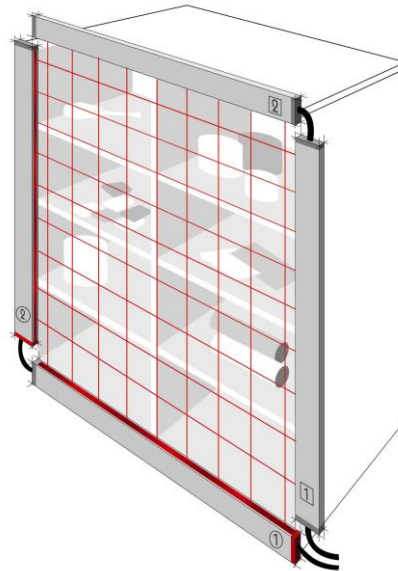
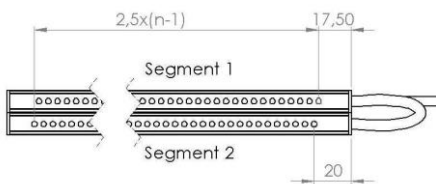

For exposure to very low temperatures as well as condensation our profiles can be heated.

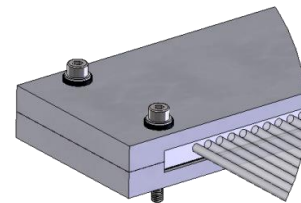
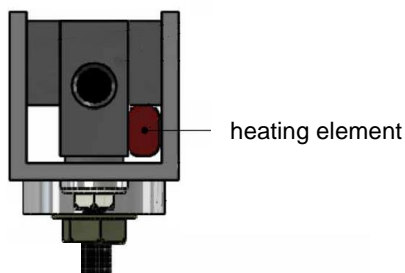

BLI: Heated profiles with 5 mm spacing

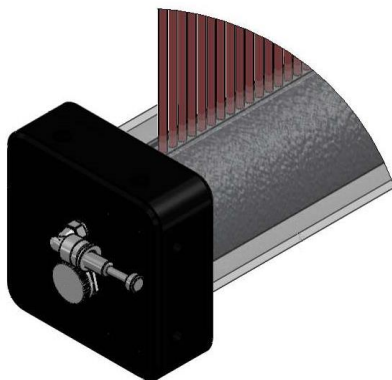

### Specialty Enclosure

Transparent enclosure pipe for increase of IP rating



### Specialty Enclosure

Light Grids mounted in a U-shaped metal bracket